

Magnetically Compensated Choke, 1- and 3-phase



**Description**

- Current compensated choke
- 1- or 3-phase choke
- THT terminals or wire leads
- Flange for mounting onto printed circuit board
- Fully potted resin

**Standards**

- EN 60938
- IEC 60950
- T.2
- VDE 0565

**Applications**

- Attenuation of common mode interferences
- May also be used in direct current applications where magnetic compensation is required
- Designed for 230/400 VAC applications

**Weblinks**

[pdf](#), [html](#), [General Product Information](#), [Approvals](#), [RoHS](#), [CHINA-RoHS](#), [e-Shop](#), [SCHURTER-Stock-Check](#), [Distributor-Stock-Check](#)

**Technical Data**

Rated voltage	up to 440 VAC	Test Voltage	1.8kV, 50Hz, 1 min, winding to winding
Rated Current	0.5 - 15A @ Ta 40 °C	Isolation Voltage	2kV eff., winding to ambient
Rated inductance	1 - 20mH, Tol. -30% +50%	Climatic Category	25/100/21 acc. to IEC 60068-1
Power Operating Frequency	50 - 400Hz	Allowable Operation Temp.	-25 °C to 100 °C
Terminal technic	THT, Flexible wire		
Weight	6 - 163g		
Material: Housing	UL 94V-0		
Sealing Compound	UL 94V-0		

**Dimensions**

Case 03

Case 07

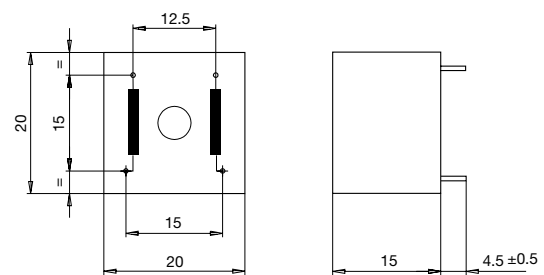
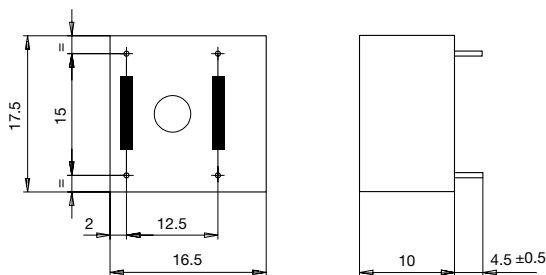

Case 11

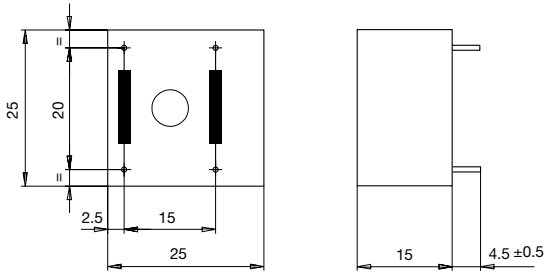

Case 12

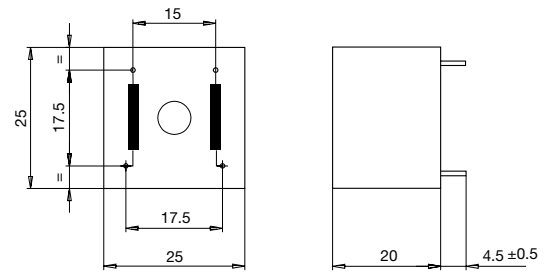

Case 20

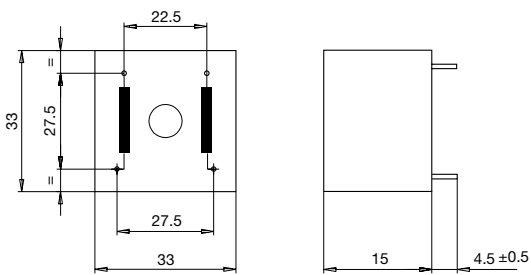

Case 25-2

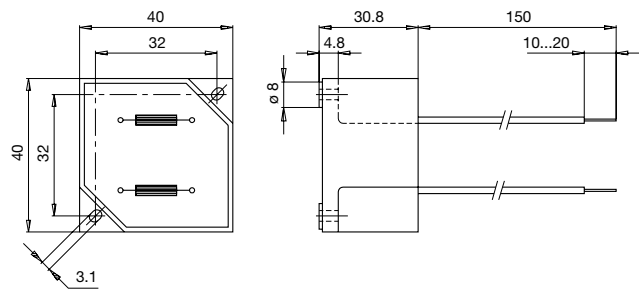

Case 29-4

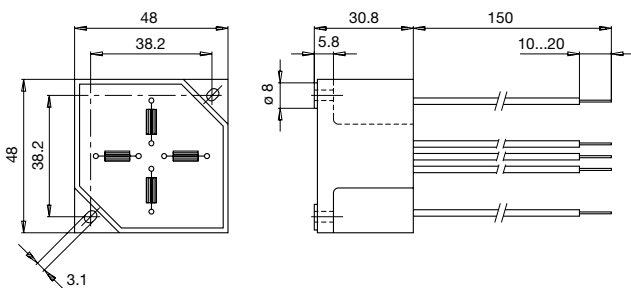

Diagrams

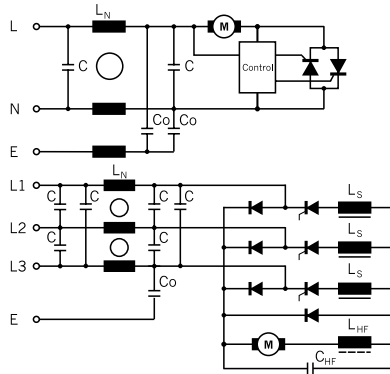

$L_N$ : Radio interference suppression choke (magnetically compensated DF)  
 $L_S$ : Radio interference suppression choke (magnetically saturated DFS/DFL)

Impedance curves

DFK-175-xxxx, DFK-20-xxxxx

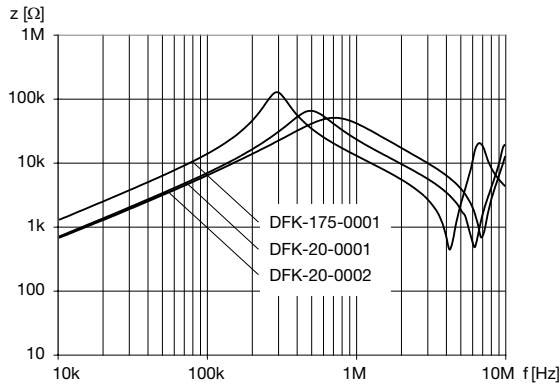

DFK-25-xxxx, DFK-40-xxxxx

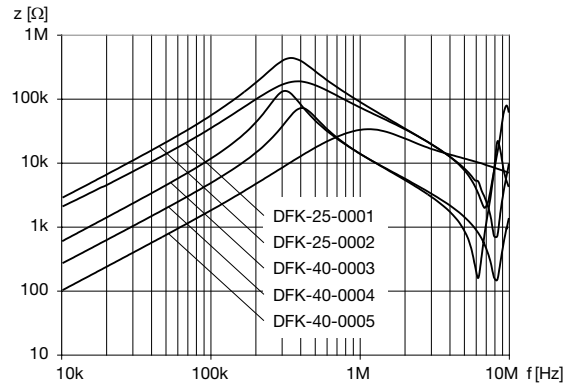

DFK-33-xxxx, DFK-48-xxxxx

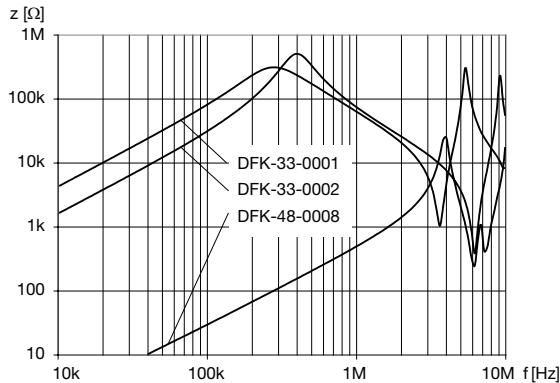

Variants

$I_n$ [A]	$L_n$ [mH]	$R_{cu}$ [mΩ]	$f_{RES}$ [MHz]	Copper $\phi$ [mm]	Weight [g]	Housing	Packing unit [pcs.]	Order Number
0.5	10	900	0.5	0.5	6	03	100	DFK-175-0001
1	10	500	0.7	0.6	12	07	150	DFK-20-0001
1	20	500	0.5	0.6	12	07	150	DFK-20-0002
1	10	510	0.5	0.6	18	11	50	DFK-25-0001
2	10	250	0.5	0.6	18	12	50	DFK-25-0002
2	20	250	0.3	0.6	37	20	45	DFK-33-0001
3	10	150	0.38	0.6	37	20	45	DFK-33-0002
6	4	27	0.4	-	127	25-2	10	DFK-40-0003
10	2	9	1.45	-	127	25-2	10	DFK-40-0004
15	1	10	1.45	2.5 x 2.5	127	25-2	10	DFK-40-0005
6	4 x 1.5	20	0.2	1.5 x 1.5	163	29-4	10	DFK-48-0008