

IEC Appliance Inlet C14 with Fuseholder 1- or 2-pole



Screw-on mounting



Snap-in version



Fuse holder "Fingergrip" with voltage selector



See below:
[Approvals and Compliances](#)

Description

- Panel mount :
 Screw-on version from front or rear side, snap-in version front side
- 3 Functions :
 Appliance Inlet Protection class I , Fuseholder for fuse-links 5 x 20 mm
 1- or 2-pole , with or without voltage selector (step switch)
- V-Lock notch standard
- Meets the requirements of IEC 60335-1 for appliances in unattended use. This includes the enhanced requirements of glow wire tests acc. to IEC 60695-2-11 or -12 &-13.
- Quick connect terminals 4.8 x 0.8 mm

Unique Selling Proposition

- Very compact design
- Components internally wired
- Integrated voltage selector
- V-Lock cord retaining

Characteristics

- Available with or without internal connections
- Plug removal necessary for fuse-link replacement
- Suitable for use in equipment according to IEC/UL 62368-1

Other versions on request

- With solder terminals
- Fuse drawer with other voltage values
- For protection class II

References

Alternative: version with line filter [KFA](#)

Weblinks

[pdf data sheet](#), [html datasheet](#), [General Product Information](#), [Approvals](#), [Distributor-Stock-Check](#), [Accessories](#), [Detailed request for product](#)

Technical Data

| | | | |
|-----------------------------------|---|-----------------------------------|--|
| Ratings IEC | 10A / 250VAC; 50Hz | Appliance inlet/-outlet | C14 / C18 acc. to IEC 60320-1, UL 498, CSA C22.2 no. 42 (for cold conditions) pin-temperature 70 °C, 10A, Protection Class I |
| Ratings UL/CSA | 10A / 250VAC; 60Hz | | |
| Dielectric Strength | > 3kVAC between L-N | Fuseholder | 1-/2-pole, Shocksafe category PC2 acc. to IEC 60127-6, for fuse-links 5 x 20mm |
| | > 4kVAC between L/N-PE (1 min/50Hz) | | |
| Allowable Operation Temperature | -25 °C to 70 °C | Rated Power Acceptance @ Ta 23 °C | 5 x 20: 2W (1 pole)/ 1.6W (2-pole) per pole |
| IP-Protection | front side IP40 acc. to IEC 60529 | Power Acceptance @ Ta > 23°C | Admissible power acceptance at higher ambient temperature see derating curves |
| Protection against electric shock | Suitable for appliances with protection class I acc. to IEC 61140 | Voltage Selector | optional, step, 2-4 digits |
| Terminal | Quick connect terminals 4.8 x 0.8 mm | | |
| Panel Thickness S | Screw: max 8 mm | | |
| | Mounting screw torque max 0.5Nm Snap-in: 1.5/2/2.5 mm | | |
| Material: Housing | Thermoplastic, black, UL 94V-0 | | |

Approvals and Compliances



Detailed information on product approvals, code requirements, usage instructions and detailed test conditions can be looked up in [Details about Approvals](#)

SCHURTER products are designed for use in industrial environments. They have approvals from independent testing bodies according to national and international standards. Products with specific characteristics and requirements such as required in the automotive sector according to IATF 16949, medical technology according to ISO 13485 or in the aerospace industry can be offered exclusively with customer-specific, individual agreements by SCHURTER.

Approvals





The approval mark is used by the testing authorities to certify compliance with the safety requirements placed on electronic products.

Approval Reference Type: KEA

| Approval Logo | Certificates | Certification Body | Description |
|--|---------------|--------------------|--|
|  | VDE Approvals | VDE | Certificate Number: 40046508 |
|  | UL Approvals | UL | UR File Number: E93617 |
|  | CCC Approvals | CCC | CCC Certificate Number: 2017180204004083 |



Product standards

Product standards that are referenced

| Organization | Design | Standard | Description |
|--|-----------------------|------------------|---|
|  | Designed according to | IEC 60320-1 | Appliance couplers for household and similar general purposes |
|  | Designed according to | IEC 60127-6 | Miniature fuses. Part 6. Fuse-holders for miniature fuse-links |
|  | Designed according to | UL 498 | Standard for Attachment Plugs and Receptacles |
|  | Designed according to | CSA C22.2 no. 42 | General Use Receptacles, Attachment Plugs, and Similar Wiring Devices |









Application standards

Application standards where the product can be used

| Organization | Design | Standard | Description |
|--|--------------------------------|----------------|--|
|  | Suitable for applications acc. | IEC/UL 62368-1 | Audio/video, information and communication technology equipment - Part 1: Safety requirements |
|  | Suitable for applications acc. | IEC 60601-1 | Medical electrical equipment - Part 1: General requirements for basic safety and essential performance |
|  | Suitable for applications acc. | IEC 60335-1 | Safety of electrical appliances for household and similar purposes. Meets the requirements for appliances in unattended use. This includes the enhanced requirements of glow wire tests acc. to IEC 60695-2-11 or -12 & -13. |

Compliances

The product complies with following Guide Lines

| Identification | Details | Initiator | Description |
|--|--|-------------|--|
|  | CE declaration of conformity | SCHURTER AG | The CE marking declares that the product complies with the applicable requirements laid down in the harmonisation of Community legislation on its affixing in accordance with EU Regulation 765/2008. |
|  | UKCA declaration of conformity | SCHURTER AG | The UKCA marking declares that the product complies with the applicable requirements laid down in the British Amendment of Regulation (EC) 765/2008. |
|  | RoHS | SCHURTER AG | Directive RoHS 2011/65/EU, Amendment (EU) 2015/863 |
|  | China RoHS | SCHURTER AG | The law SJ / T 11363-2006 (China RoHS) has been in force since 1 March 2007. It is similar to the EU directive RoHS. |
|  | REACH | SCHURTER AG | On 1 June 2007, Regulation (EC) No 1907/2006 on the Registration, Evaluation, Authorization and Restriction of Chemicals 1 (abbreviated as "REACH") entered into force. |
|  | | SCHURTER AG | V-Lock system are based on a matching plug-dose combination. The connector is equipped with a notch intended for use with the latching cordset. The cord latching system prevents against accidental removal of the cordset. |
|  | White Paper Glow wire test | SCHURTER AG | Meets the requirements of IEC 60335-1 for appliances in unattended use. This includes the enhanced requirements of glow wire tests acc. to IEC 60695-2-11 or -12 & -13. |
|  | Medical Equipment | SCHURTER AG | Suitable for use in medical equipment according to IEC/UL 60601-1 (1 MOOP, 1 MOPP) |

Dimensions [mm]

Screw-on mounting type KEA

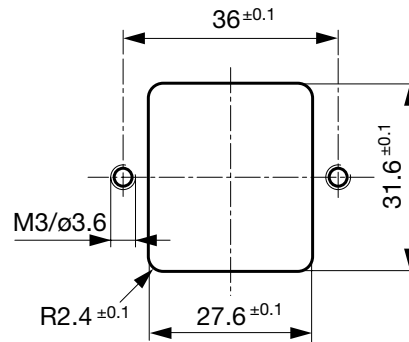
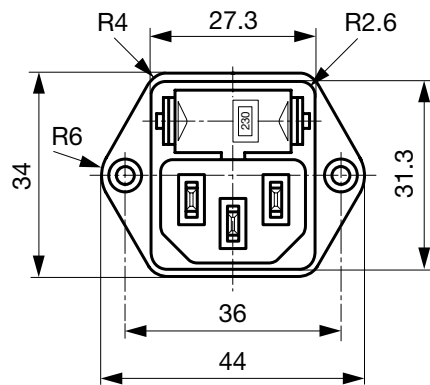
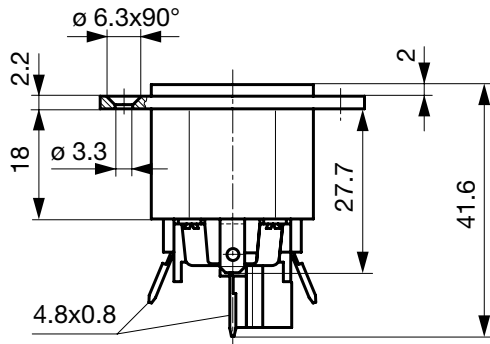

Snap-in mounting type KEA

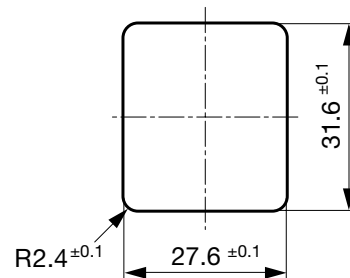
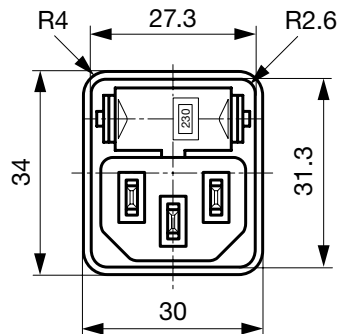
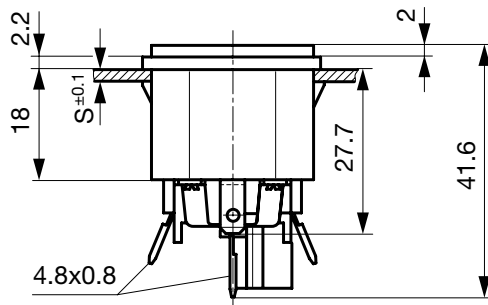

Diagrams

without conn.
Voltage Selector
4-positions, 1-pole

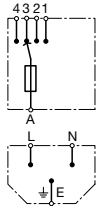

without conn.
Voltage Selector
4-positions, 2-pole

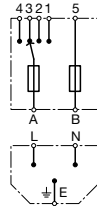

with internal connections
Voltage Selector
3-positions, 1-pole

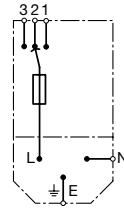

with internal connections
Voltage Selector
3-positions, 2-pole

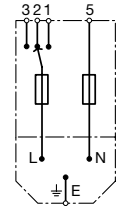

Voltage Selector
2 pos.
1-pole

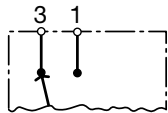

Voltage Selector
2 pos.
2-pole

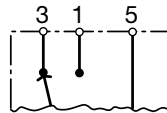

without voltage selector
1-pole

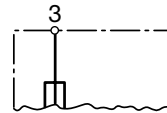

without voltage selector
2-pole

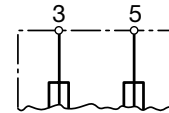

Derating Curves

1-pole

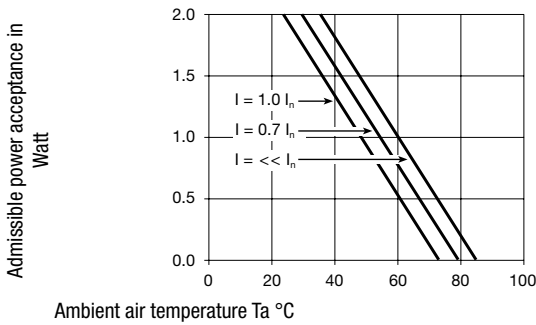

2-pole

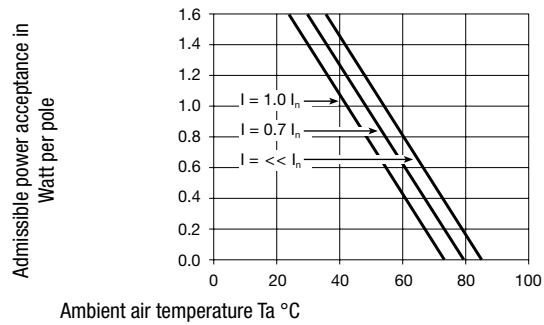

All Variants

| Type | Panel mounting | Panel Thickness s [mm] | Fuseholder | Voltage Selector | Internally wired | Order Number |
|------|----------------|------------------------|------------|------------------|------------------|--------------|
| KEA | Snap-in | 1.5 | 1-pole | - | ● | 4301.0522 |
| KEA | Snap-in | 2 | 1-pole | - | ● | 4301.0523 |
| KEA | Snap-in | 2.5 | 1-pole | - | ● | 4301.0524 |
| KEA | Snap-in | 1.5 | 1-pole | - | | 4301.2022 |
| KEA | Snap-in | 2 | 1-pole | - | | 4301.2023 |
| KEA | Snap-in | 2.5 | 1-pole | - | | 4301.2024 |
| KEA | Snap-in | 1.5 | 1-pole | 2 pos. | | 4301.2142 |
| KEA | Snap-in | 2 | 1-pole | 2 pos. | | 4301.2143 |
| KEA | Snap-in | 1.5 | 1-pole | 3 pos. | ● | 4301.0022 |
| KEA | Snap-in | 2 | 1-pole | 3 pos. | ● | 4301.0023 |
| KEA | Snap-in | 2.5 | 1-pole | 3 pos. | ● | 4301.0024 |
| KEA | Snap-in | 1.5 | 1-pole | 3/4 digits | | 4301.2062 |
| KEA | Snap-in | 2 | 1-pole | 3/4 digits | | 4301.2063 |
| KEA | Snap-in | 2.5 | 1-pole | 3/4 digits | | 4301.2064 |
| KEA | Snap-in | 1.5 | 2-pole | - | ● | 4301.0502 |
| KEA | Snap-in | 2 | 2-pole | - | ● | 4301.0503 |
| KEA | Snap-in | 2.5 | 2-pole | - | ● | 4301.0504 |
| KEA | Snap-in | 1.5 | 2-pole | - | | 4301.2002 |
| KEA | Snap-in | 2 | 2-pole | - | | 4301.2003 |
| KEA | Snap-in | 2.5 | 2-pole | - | | 4301.2004 |

| Type | Panel mounting | Panel Thickness s [mm] | Fuseholder | Voltage Selector | Internally wired | Order Number |
|------|----------------|---------------------------|------------|------------------|------------------|--------------|
| KEA | Snap-in | 1.5 | 2-pole | 2 pos. | | 4301.2122 |
| KEA | Snap-in | 2 | 2-pole | 2 pos. | | 4301.2123 |
| KEA | Snap-in | 2.5 | 2-pole | 2 pos. | | 4301.2124 |
| KEA | Snap-in | 1.5 | 2-pole | 3 pos. | ● | 4301.0002 |
| KEA | Snap-in | 2 | 2-pole | 3 pos. | ● | 4301.0003 |
| KEA | Snap-in | 2.5 | 2-pole | 3 pos. | ● | 4301.0004 |
| KEA | Snap-in | 1.5 | 2-pole | 3/4 digits | | 4301.2042 |
| KEA | Snap-in | 2 | 2-pole | 3/4 digits | | 4301.2043 |
| KEA | Snap-in | 2.5 | 2-pole | 3/4 digits | | 4301.2044 |
| KEA | Screw | - | 1-pole | - | ● | 4301.0521 |
| KEA | Screw | - | 1-pole | - | | 4301.2021 |
| KEA | Screw | - | 1-pole | 2 pos. | | 4301.2141 |
| KEA | Screw | - | 1-pole | 3 pos. | ● | 4301.0021 |
| KEA | Screw | - | 1-pole | 3/4 digits | | 4301.2061 |
| KEA | Screw | - | 2-pole | - | ● | 4301.0501 |
| KEA | Screw | - | 2-pole | - | | 4301.2001 |
| KEA | Screw | - | 2-pole | 2 pos. | | 4301.2121 |
| KEA | Screw | - | 2-pole | 3 pos. | ● | 4301.0001 |
| KEA | Screw | - | 2-pole | 3/4 digits | | 4301.2041 |

Most Popular.

Availability for all products can be searched real-time: <https://www.schurter.com/en/info-center/support-tools/stock-check-distributors>

The fuse drawer is not included and must be ordered separately (see required accessory).

| | |
|-----------------------|--------|
| Packaging unit | 50 Pcs |
|-----------------------|--------|

Required Accessory

Description

Fusedrawer_2

Fusedrawer for Fuse Links 5x20 mm, with or without Voltage Selector Insert



| | |
|---|--------------|
| Fingergrip-Safe, 2-pole | 3-104-672 |
| Fingergrip, 2-pole, Voltage Selector, 110, 150, 220 | 4301.1014.01 |
| Fingergrip, 2-pole, Voltage Selector, 120, 240 | 4301.1014.02 |
| Fingergrip, 2-pole, Voltage Selector, 110, 220 | 4301.1014.03 |
| ... | ... |

Accessories



Wire_Harness

Wire harness for SCHURTER products



Assorted_Covers

Rear Cover

| |
|-----------|
| 0859.0047 |
|-----------|



RC320
 Rear Cover for Power Entry Module



Cord_retaining_kits
 Cord retaining strain relief

| | |
|----------------|-----------|
| Flat head, A | 4700.0001 |
| Countersunk, B | 4700.0002 |

Mating Outlets/Connectors

Category / Description

[Appliance Outlet Overview complete](#)



| | |
|--|------|
| 4787, Mounting: Screw-on mounting, Appliance Outlet: IEC Solder terminals, 10 A, Suitable for appliances with protection class I | 4787 |
| 4788, Mounting: Snap-in version, Appliance Outlet: IEC Solder / Quick Connect, 10 A, Suitable for appliances with protection class I | 4788 |
| IEC Appliance Outlet F or H, Screw-on Mounting, Front Side, Solder, PCB or Quick-connect Terminal | 5091 |

[Connector Overview complete](#)



| | |
|---|---------|
| 4782 Mounting: Power Cord, 3 x 1 mm ² / 3 x 18 AWG, Cable, Connector: IEC C13 | 4782 |
| 4785 Mounting: Power Cord, 3 x 1 mm ² / 3 x 18 AWG, Cable, Connector: IEC C13 | 4785 |
| 4300-06 Mounting: Power Cord, 3 x 1 mm ² / 3 x 18 AWG, Cable, Connector: IEC C13 | 4300-06 |
| 4781 Mounting: Power Cord, Cable, Connector: IEC C15 | 4781 |
| 4784 Mounting: Power Cord, 3 x 1 mm ² / 3 x 18 AWG, Cable, Connector: IEC C15 | 4784 |

Mating Outlets/Connectors shuttered

[Connector Overview complete](#)



| | |
|--|------|
| 4783 Mounting: Power Cord, 3 x 1 mm ² / 3 x 18 AWG, Cable, Connector: IEC C13 | 4783 |
|--|------|

[Power Cord Overview complete](#)



| | |
|---|---------|
| VAC13KS, Overview, V-Lock cord retaining, diverse Connector IEC C13, diverse, black | VAC13KS |
| VAC17KS, V-Lock cord retaining, diverse m, Connector IEC C17, diverse, black / grey / white | VAC17KS |